

SPECIFICATIONS

RESOLUTION	
Pixels used for picture taking	80 (V) x 180 (H) pixels
Capturing scope	0.25 x 0.54 mm
1 centre + 12 peripheral measurements	13 x fixation points
Photography magnification	x 190
Display	10.4" colour LCD
MEASUREMENT	
Auto alignment	Yes
Auto measurement	Yes
Manual mode (1 & 2)	Yes
MEASUREMENT FUNCTION	
Automated captured examination	16 pictures for analysis
Number of analysed cells	Up to 300 cells
Capturing position	Center + 12 peripheral points
Analysis method	Automatic analysis, L-count, Core method, Dark area method
Analysis values	CD (cell density) AVG (average cell area) SD (standard deviation of cell area) CV (coefficient of variation of cell area) Cell size (max. + min. cell area)
Stroke of moving section	X: 88 mm Y: 40 mm Z: 50 mm
Stroke of electrical chin rest	70 mm
Measuring accuracy Pachymetry	+/- 10 µm
DATA MANAGEMENT	
Built in printer	Thermal printer
Data output type	USB-Hx2, USB-Dx2, LAN, SD Card (for internal database)
OPERATING ENVIRONMENT	
Temperature	+10° to +40°
Humidity	30 % to 75 %
Atmospheric pressure	800 to 1060 hPa
Standards applied	MDD Annex ii, iSo 13485

DIMENSIONS & ELECTRIC REQUIREMENTS

Dimensions WDH	309 x 491 x 450 mm
Weight	Approx. 22 kg
Voltage	AC 100 to 240 V
Frequency	50/60 Hz
Power consumption	100 VA

DIMENSIONS

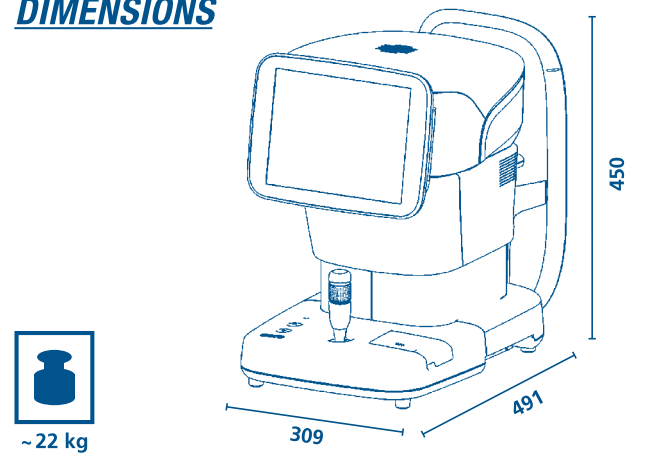

WIDE CAPTURING AREAS INCLUDING PERIPHERAL

Different fixation targets enable you to capture images also in the periphery – 13 different areas in total! The wide range of positions increases the chance of capturing images on patients with partial cornea opacity.

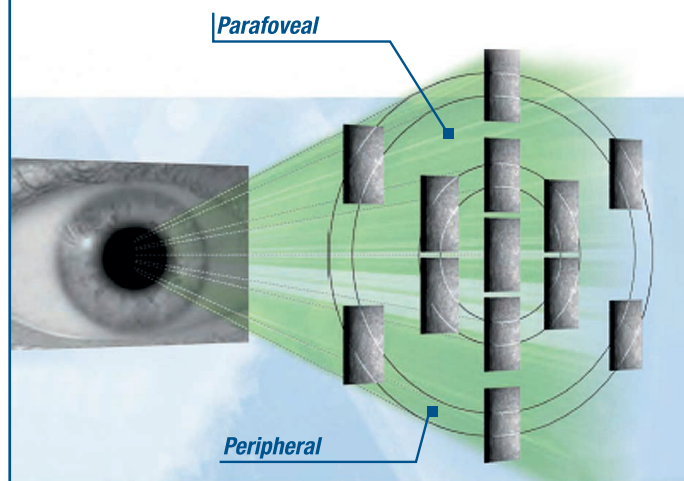

2019/07 - subject to change without notice

SPECULAR MICROSCOPE EM-4000

ENDOTHELIUM ANALYSIS + PACHYMETRY

DELIGHT IN SIGHT

Stand alone, fast and easy handling.

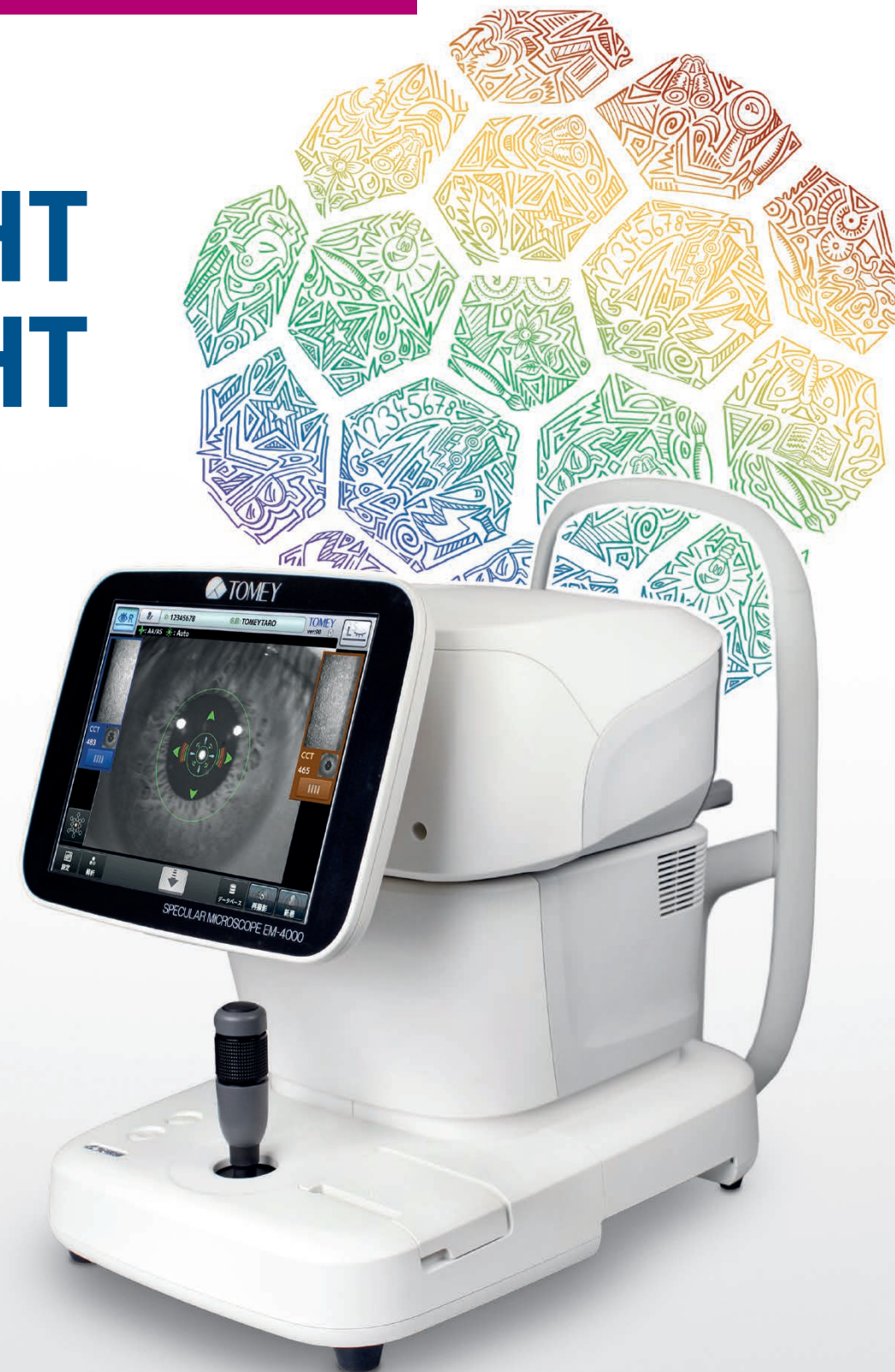

- Auto alignment + auto measurement
- Integrated non-contact Pachymetry
- 13 measurement areas
- Integrated database and printer
- Automatic analysis, L-count, Core method, Dark area method
- Counts up to 300 cells
- Extremely fast

TOMEY
TECHNOLOGY AND VISION



TOMEY EUROPE
TOMEY GmbH
Wiesbadener Straße 21
90427 Nürnberg, Germany
Phone +49 911 938 546 2 0
Fax +49 911 938 546 2 20
Email info@tomey.de

TOMEY ASIA-PACIFIC
TOMEY CORPORATION JAPAN
2-11-33 Noritakeshinmachi
Nishi-ku, Nagoya 451-0051, Japan
Phone +81 52 581 5327
Fax +81 52 561 4735
Email intl@tomey.co.jp

TOMEY
TECHNOLOGY AND VISION

www.tomey.de

THE TOMEY EM-4000 SPECULAR MICROSCOPE



QUALITY IN DETAIL

Non-contact examination, auto alignment and measurement plus automatic analysis of the endothelium layer make working with the **EM-4000** professional and quick (4 sec. for both eyes). Thanks to our auto alignment technology we can assure the reproducibility of the measured area and therefore also the analysed values.

The integrated non-contact Pachymetry will be automatically measured with every central examination. The big colour touch screen is used as an operating monitor as well as for displaying all measured values. All commands can be given via touch screen.

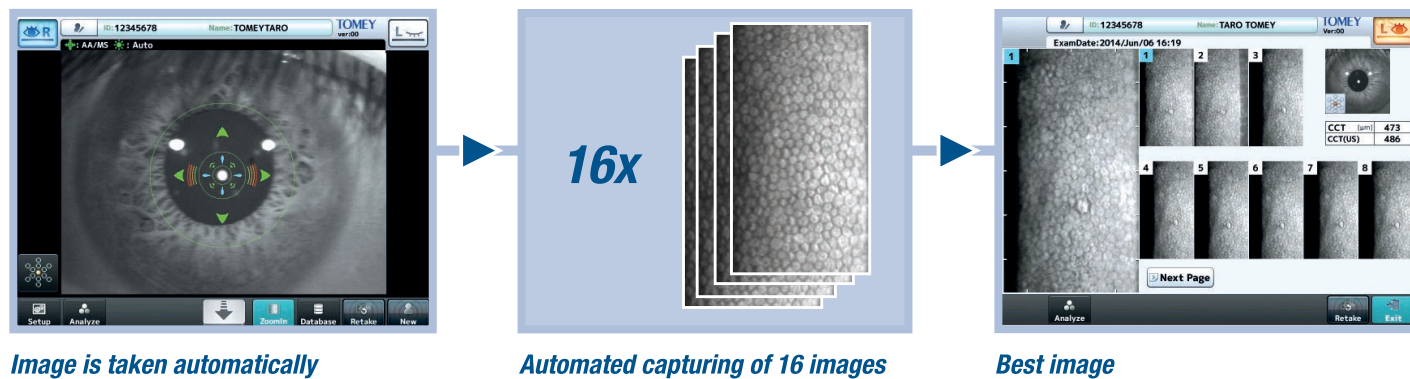
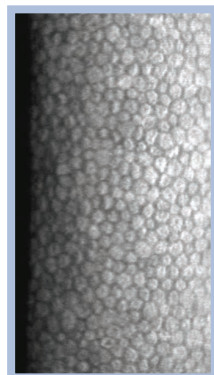

Image is taken automatically

Automated capturing of 16 images

Best image



Endothelium layer

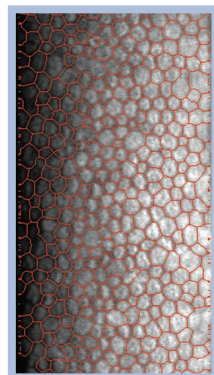

Traced image

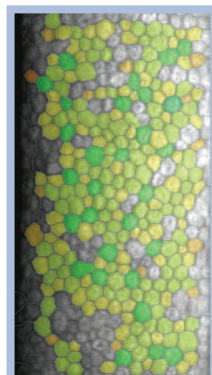

Different sizes displayed in colours



Polygonal shapes displayed in colours

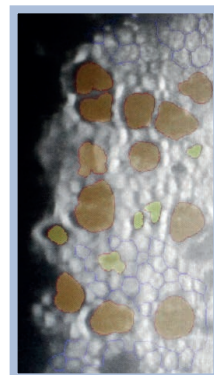

Dark area analysis

AUTO ALIGNMENT + AUTO MEASUREMENT

The handling of the **EM-4000** is very easy – it does almost everything by itself. Alignment and measurement are done automatically. Of course you also can do the examination in the manual mode.

13 MEASUREMENT AREAS + AUTOMATIC PACHYMETRY

The **EM-4000** has a very large measurement area. With up to 300 counted cells the system assures a representative cell density analysis of your patients' cornea. Images can be taken at 13 positions: the centre and 12 peripheral points. Additional to that the thickness of the cornea will be automatically measured with every central exam – of course in non contact method.

FAST AND FULLY AUTOMATED ANALYSIS OF CORNEAL ENDOTHELIUM CELLS

The software evaluates all relevant data respective to the endothelium, such as the density of cells as well as Polymegathism and Pleomorphism (morphology). High-quality images enable discovering irregularities or possible degeneration of the endothelium. For these difficult cases you can use the classical L-count function, the Core method and our special Dark area analysis tool.

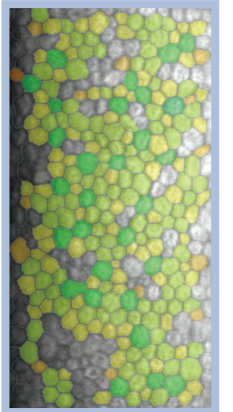

Trace method

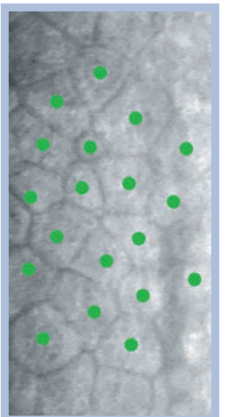

Core method

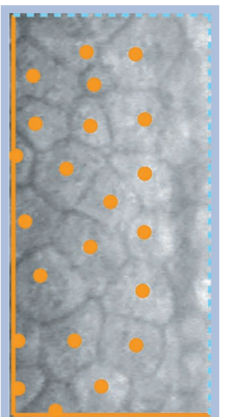

L-count method

You can choose between automatic or manual analysis.

DATABASE FUNCTION & BUILT-IN PRINTER

A database function is provided in the main unit. Two selected measurements can be displayed simultaneously, allowing you to compare observations before and after surgery for the same patient. Data for approx. 16,000 patients can be stored in the SD card set in the main unit.

Performing reanalysis using a different analysis method is possible by retrieving data which has been stored. Printout displays the endothelium image and the analysis result.

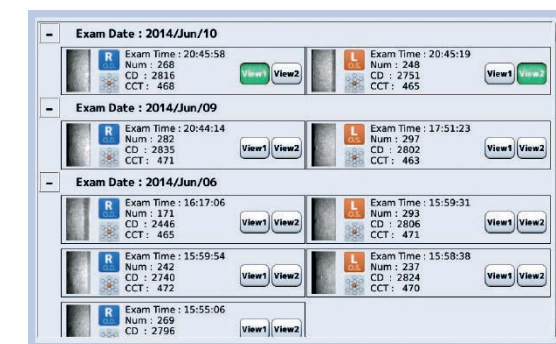

Integrated database

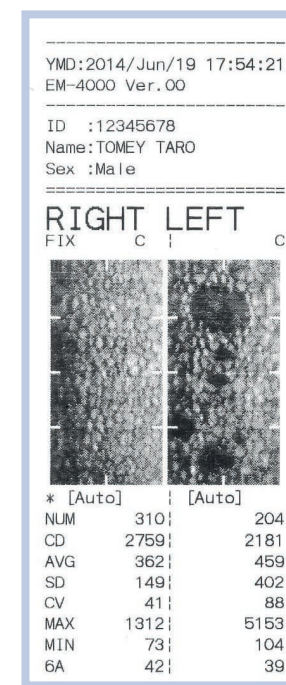

Built-in printer